

Roy City

Transportation Master Plan

Roy, Utah

December 2018

Prepared by:

A-Trans Engineering, LLC

P.O. Box City, 521651

Salt Lake City, Utah 84152

(801) 949-0348

atrans@comcast.net

Wasatch Civil Consulting Engineering

1150 Depot Drive #225

Ogden, UT 84404

(801) 775-9191



Table of Figures

Figure 1: Existing Road Network 4

Figure 2: Existing Average Annual Daily Traffic..... 7

Figure 3: Existing Intersection Turning Movement Counts 8

Figure 4: Existing Intersection Control and Level of Service..... 9

Figure 5: 2040 WFRC AADT Projections..... 11

Figure 6: Buildout Classification Map..... 15

Figure 7: City Cross Sections (1 of 5)..... 16

Figure 8: City Cross Sections (2 of 5)..... 17

Figure 9: City Cross Sections (3 of 5)..... 18

Figure 10: City Cross Sections (4 of 5)..... 19

Figure 11: City Cross Sections (5 of 5)..... 20

Figure 12: Transit Facilities Map..... 23

Figure 13: Trails and Bike Plan 24

Figure 14: Posted Speed and 85th Percentile Speeds..... 26

Figure 15: Traffic Calming Locations 31

Figure 16: Accident Summary 32



Introduction

Settled in 1873 and incorporated in 1937, Roy City is in Weber County, Utah, along the Interstate 15 corridor. With a 2010 census population of 36,884 and a 2017 population of 38,595, it is part of the Ogden metropolitan area. Roy City is surrounded by other incorporated Cities and therefore expansion opportunities are minimal. In this regard, traffic growth from internal development is limited but Roy's geographical location creates a need to accommodate traffic growth generated by the surrounding communities. The Roy City Transportation Master Plan (TMP) provides the recommended roadway sizing to accommodate future transportation needs for all modes of transportation.

Roy Population Projections

2020 - 39,979

2030 - 41,890

2040 - 43,876

2050 - 44,739

2060 - 44,618

As part of the TMP, the current roadway network was assessed using current traffic volumes. Traffic volumes were also projected through the year 2040 using the current roadway network to find the capacity improvements necessary for the roadway network.

ROADWAY NETWORK

To have an effective transportation system, the City requires a connected street system. A connected street system improves traffic congestion, commute times, emergency response times, etc. Roadways share two functions: mobility and land access. These two functions share an inverse relationship, meaning a roadway with high mobility has minimal land access points and a roadway with low mobility has frequent land access points. Roadway classifications are necessary in a connected roadway network to designate the amount of mobility and land access the roadway will have. The following roadway classification is used in Roy City: Freeway, Arterial Street, Collector Street, and Local Street. These classifications range from most mobile and least land access points (Freeway) to least mobile with frequent land access points (Local Street), creating a hierarchy in the roadway system. Intersections are used in the roadway system to allow for the progression from high mobility to low mobility and land access. Freeways connect with Arterial Streets, which connect with Collector Streets, which connect with Local Streets. Correct use of all roadway classification types within the City allows for a successful, connected roadway system.

There are four primary roadway classifications:

Local Streets – These facilities primarily serve land-access functions. Their design and control facilitates the movement of vehicles onto and off the street system from land parcels. Through movement is difficult and is discouraged by both the design and control of the facility.

Collectors – These facilities, the “middle” classification, are intended to serve both through and land-access functions in relatively equal proportions. For long through trips, such facilities are usually inefficient, though they are frequently used for shorter through movements associated with the distribution and collection portion of trips.

Arterials – These facilities are provided to service primarily through-traffic movement. While some land-access service may be accommodated, it is clearly a minor function, and all traffic controls and the facility design are intended to provide efficient through movement.

Freeways and Expressways – These facilities are provided to service long distance trips between cities and states. No land access is provided by these facilities.

To measure the performance of a roadway segment, Level of Service (LOS) is used. The purpose of LOS as defined by the Federal Highway Administration (FHWA) is to determine the level of congestion on a roadway segment or intersection. To measure LOS, each roadway segment is assigned a letter grade A through F where A represents free flowing traffic and F represents grid lock. LOS is measured on a roadway segment using a daily traffic volume and at an intersection based on the average delay per vehicle. The LOS of a roadway segment or intersection is used to determine if capacity improvements are necessary. Urbanized areas typically accept LOS D or better in peak periods as a design and operational goal.

As part of the TMP, data was collected for the existing roadway network and a LOS was determined for each roadway segment and intersection. The existing traffic volumes were projected to 2040 using the Wasatch Front Regional Council (WFRC) travel demand model. The WFRC is a collaboration of local government and community members from Salt Lake, Weber, Tooele, Morgan and Box Elder counties in Utah to plan future growth. The projected traffic volumes were applied to the existing roadway system and all roadway segments were assigned a LOS. The segments with LOS E or worse with the 2040 projected traffic volumes will undergo capacity improvements to achieve an acceptable LOS.

Existing Roadway Network

The primary routes within Roy City are 1900 West, Midland Drive, 3500 West, 5600 South, 4800 South, 4000 South and Hinckley Drive.

TRAFFIC VOLUMES AND LEVEL OF SERVICE

Data collection was performed in conjunction with the TMP. This included collected data from the City, UDOT, and new traffic counts on many of the City roads. The volume data serve to show any capacity deficiencies that may exist today.

For intersections, LOS is related to the length of time the average vehicle will have to wait at a signal before proceeding through the intersection. LOS F is seen where an average vehicle must wait longer than 80 seconds to proceed through an intersection. Intersection and roadway segment LOS problems must be solved independently of each other as the treatment required to mitigate the congestion is different in each case. Roadway segment LOS can be mitigated with geometry improvements, additional lanes, two-way-left turn lanes, and access management. Intersection problems may be mitigated by adding turn lanes, improving signal timing, and improving corridor signal coordination.

NETWORK CAPACITY

Roadway capacity is determined using roadway classification and the number of lanes. Table 1 shows the LOS C, LOS D and LOS E thresholds for arterials and collectors from Wasatch Front Regional Council (WFRC). Figure 1 shows the existing roadway network and classification of key roadways within Roy City.

Table 1: Roadway Capacities

	Wasatch Front Regional Council					
	Arterial			Collector		
Number of Lanes	LOS C	LOS D	LOS E	LOS C	LOS D	LOS E
2 Lane	10000	11500	15000	9000	10500	13500
3 Lane	11500	13000	16500	10000	11500	15000
4 Lane	25000	29000	36500	19000	22500	28500
5 Lane	26500	30500	39000	21500	25000	31500
6 Lane	35000	40500	52000			
7 Lane	40000	46000	59000			

LEGEND

-  ROUNDABOUT
-  TRAFFIC SIGNAL
-  COMMUTER RAIL STATION
-  MAJOR ARTERIAL ROADWAY OPTION A
-  MAJOR ARTERIAL ROADWAY OPTION B
-  MINOR ARTERIAL ROADWAY
-  MAJOR COLLECTOR ROADWAY
-  MINOR COLLECTOR ROADWAY
-  RESIDENTIAL ROADWAY
-  UDOT OWNED ROADWAY

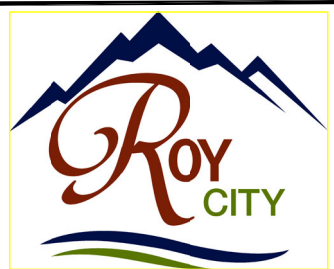
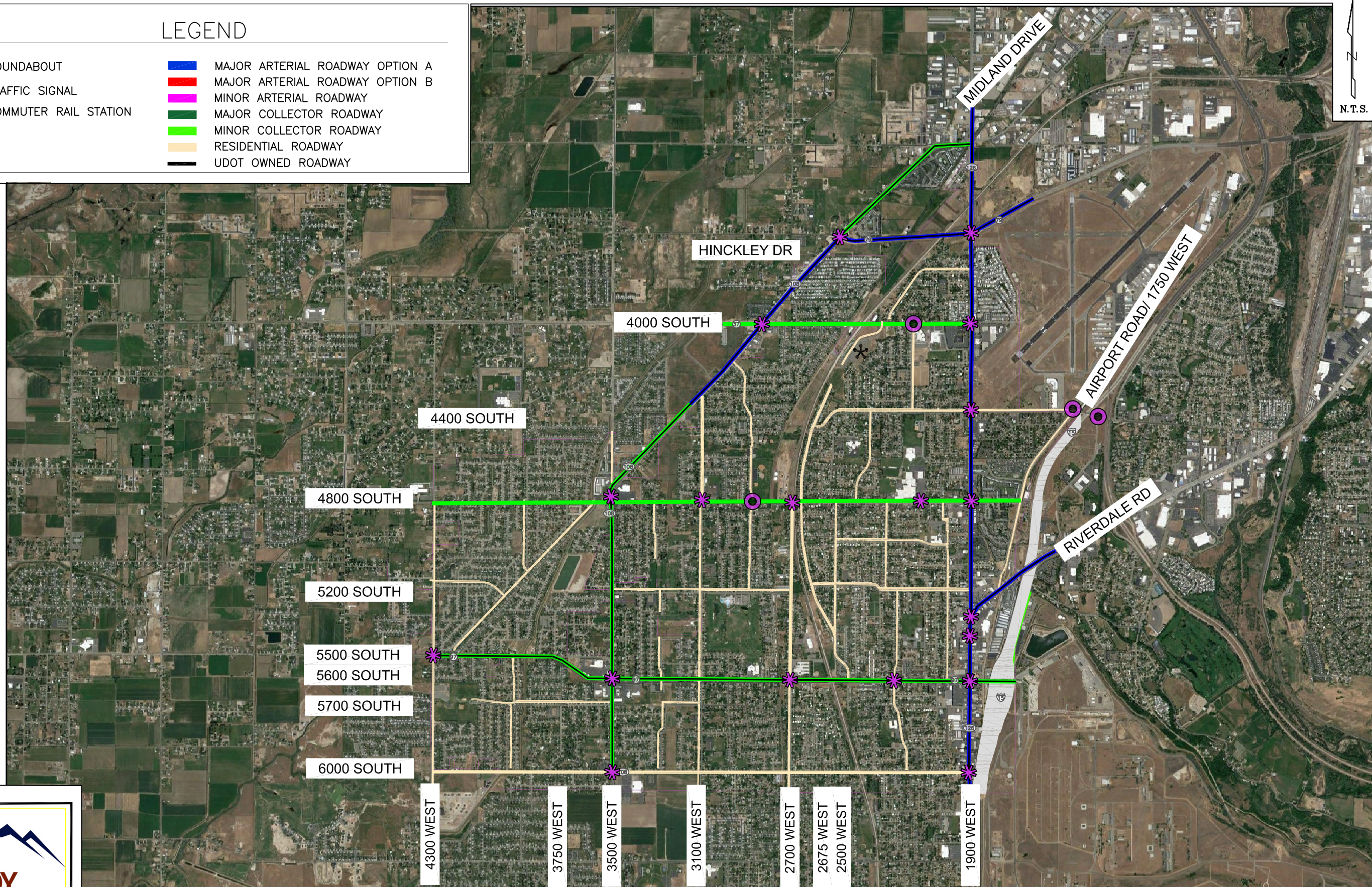

5051 South 1900 West
Roy, Utah 84067

November 2018

Figure 1

Existing Road Network

Existing Traffic Volumes

a. Average Annual Daily Traffic

Average Annual Daily Traffic (AADT) is the primary measure for determining roadway size and geometric need. Table 2 identifies the primary roadway segments, the route, speed limit and existing AADT. Figure 2 shows the existing AADT by road segment.

Table 2: Road Network Classification

ROADWAY	FROM	TO	ROUTE #	Speed	EXISTING AADT
HINCKLEY	MIDLAND	1900 WEST	79	50	10045
4000 SOUTH	MIDLAND	SANDRIDGE DR	3318	35	9530
4000 SOUTH	SANDRIDGE DR	1900 WEST	3318	35	9650
4400 SOUTH	1900 WEST	AIRPORT ROAD	3316	35	10140
4800 SOUTH	4700 WEST	3500 WEST	3308	35	2715
4800 SOUTH	3500 WEST	2700 WEST	3308	35	11880
4800 SOUTH	2700 WEST	1900 WEST	3308	35	13700
5500 SOUTH	4300 WEST	3500 WEST	97	40	13840
5600 SOUTH	3500 WEST	2700 WEST	97	35	16585
5600 SOUTH	2700 WEST	2500 WEST	97	35	17625
5600 SOUTH	2500 WEST	1900 WEST	97	35	24040
5600 SOUTH	1900 WEST	FREEWAY PARK DR	97	35	32600
RIVERDALE RD	1900 WEST	I-15 RAMP	26	35	21000
6000 SOUTH	3500 WEST	1900 WEST	3310	35	4440
MIDLAND	HINCKLEY	4000 SOUTH	108	45	13760
MIDLAND/3500 WEST	4000 SOUTH	5600 SOUTH	108	45	18940
3500 WEST	5600 SOUTH	6000 SOUTH	108	45	20985
4300 WEST	5500 SOUTH	6000 SOUTH	1483	25	1010
1900 WEST	MIDLAND	HINCKLEY	126	45	14755
1900 WEST	HINCKLEY	4000 SOUTH	126	45	21860
1900 WEST	4000 SOUTH	4400 SOUTH	126	45	22745
1900 WEST	4400 SOUTH	RIVERDALE RD	126	45	24485
1900 WEST	RIVERDALE RD	5600 SOUTH	126	45	38615
1900 WEST	5600 SOUTH	1800 NORTH	126	45	25200

b. Turning Movement Counts and Analysis

Existing traffic counts for key locations within the City were performed in September and October of 2018. Additional count data was provided by A-Trans Engineering, from other traffic impact studies performed within the last 2 years, and from UDOT’s Signal Performance Metrics Website. This data is compiled and shown in Figure 3.

Table 3 shows the LOS range by delay for unsignalized and signalized intersections and accesses. Figure 4 shows the existing intersection control and level of service.

Table 3: Intersection LOS-Delay Relationship

	Unsignalized	Signalized
Level of Service	Total Delay per Vehicle (sec)	Total Delay per Vehicle (sec)
A	≤ 10.0	≤ 10.0
B	> 10.0 and ≤ 15.0	> 10.0 and ≤ 20.0
C	> 15.0 and ≤ 25.0	> 20.0 and ≤ 35.0
D	> 25.0 and ≤ 35.0	> 35.0 and ≤ 55.0
E	> 35.0 and ≤ 50.0	> 55.0 and ≤ 80.0
F	> 50.0	> 80.0

LEGEND

2016 AADT (XXXX)
 2016 Data Provided by Roy City (XXXX)
 2018 Data Provided by Roy City (XXXX)

2016 Data from Traffic on Utah Highways

- MAJOR ARTERIAL ROADWAY OPTION A
- MAJOR ARTERIAL ROADWAY OPTION B
- MINOR ARTERIAL ROADWAY
- MAJOR COLLECTOR ROADWAY
- MINOR COLLECTOR ROADWAY
- RESIDENTIAL ROADWAY

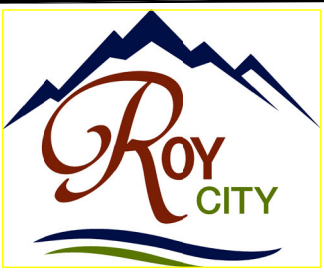
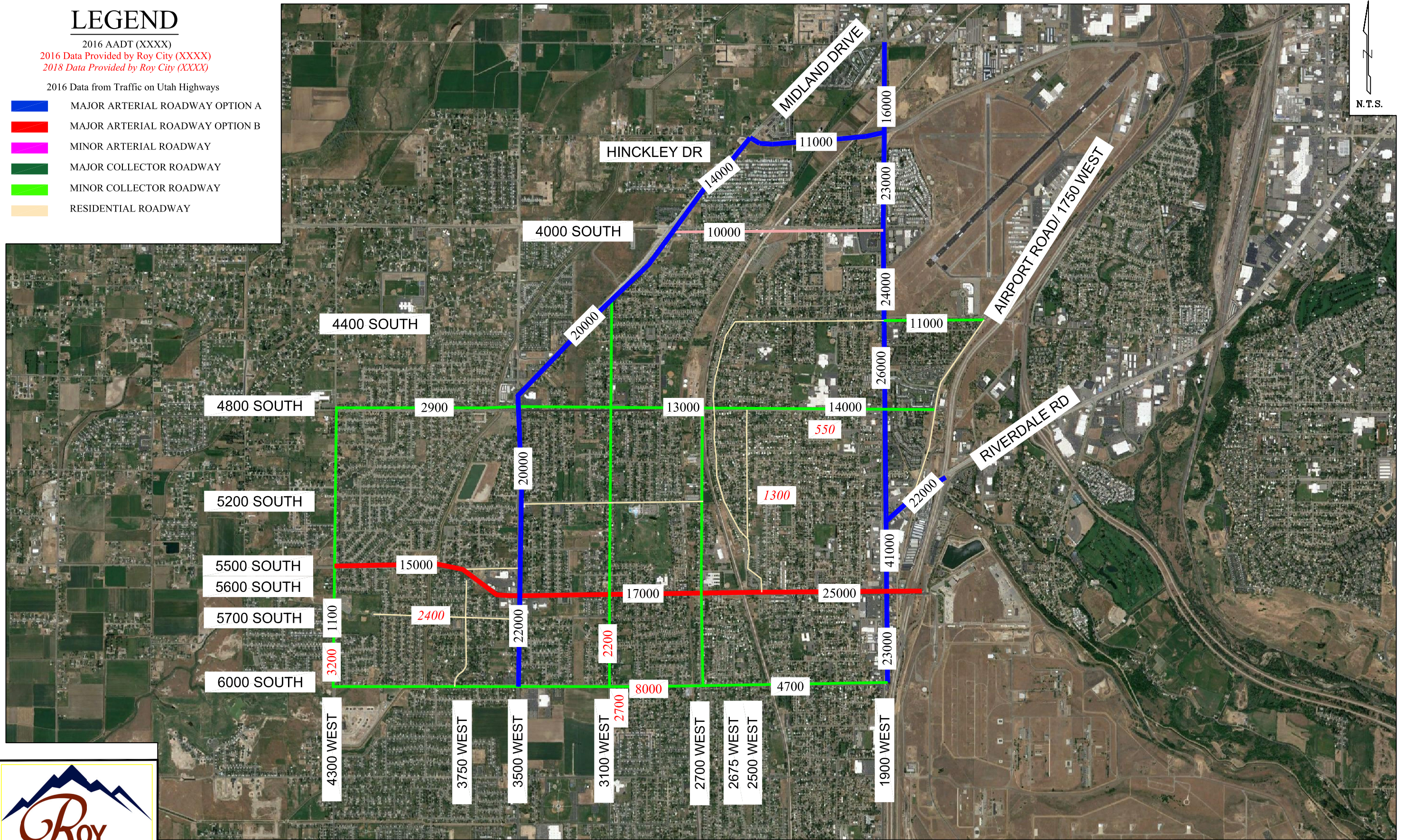

5051 South 1900 West
 Roy, Utah 84067

November 2018

Figure 2

Existing Average Annual Daily Traffic

1 (10) 27 ↘ (55) 137 ↘ (4) 1 ↘ ↘ 8 (29) ↘ 371 (848) ↘ 70 (37)	2 (185) 371 ↘ (137) 264 ↘ (27) 21 ↘ ↘ 145 (63) ↘ 81 (247) ↘ 39 (160)	3 ↘ 404 (1269) ↘ 25 (62)	4 (706) 1059 ↘ (23) 7 ↘ ↘ 10 (7) ↘ 2 (11)	5 (703) 1017 ↘ (27) 13 ↘ ↘ 160 (80) ↘ 4 (6)
6 (15) 67 ↘ (5) 11 ↘ ↘ 14 (40) ↘ 371 (972)	7 (308) 553 ↘ (19) 109 ↘ ↘ 158 (531) ↘ 43 (25)	8 (46) 95 ↘ (56) 87 ↘ (63) 54 ↘ ↘ 73 (70) ↘ 493 (1027) ↘ 165 (215)	9 (869) 706 ↘ (30) 12 ↘ ↘ 36 (15) ↘ 18 (21)	
10 (1) 0 ↘ (458) 544 ↘ (3) 3 ↘ ↘ 17 (25) ↘ 1 (2) ↘ 4 (4)	11 (4) 1 ↘ (35) 18 ↘ ↘ 1 (0) ↘ 41 (77)	12 (18) 8 ↘ (395) 476 ↘ (12) 7 ↘ ↘ 12 (26) ↘ 15 (22) ↘ 30 (53)	13 (43) 22 ↘ (72) 63 ↘ (18) 14 ↘ ↘ 17 (37) ↘ 538 (801) ↘ 340 (350)	
14 (28) 17 ↘ (17) 3 ↘ (32) 9 ↘ ↘ 26 (23) ↘ 0 (0) ↘ 10 (46)	15 (37) 13 ↘ ↘ 2 (2) ↘ 22 (30)	16 (27) 19 ↘ (587) 519 ↘ (45) 19 ↘ ↘ 27 (70) ↘ 15 (58) ↘ 15 (16)	17 (3) 1 ↘ (29) 34 ↘ (5) 3 ↘ ↘ 2 (6) ↘ 2 (0) ↘ 33 (11)	
AM (PM) ↘ 24 (30) ↘ 0 (0) ↘ 38 (0) ↘ 13 (58) ↘ 1 (15) ↘ 97 (97)	18 (20) 6 ↘ (237) 431 ↘ (64) 25 ↘ ↘ 24 (46) ↘ 51 (65) ↘ 23 (10)	19 (41) 81 ↘ (251) 517 ↘ (11) 13 ↘ ↘ 17 (57) ↘ 25 (52) ↘ 10 (18)	20 (30) 0 ↘ (0) 22 ↘ (22) 13 ↘ ↘ 11 (40) ↘ 25 (87) ↘ 6 (18)	
	↘ 13 (53) ↘ 22 (70) ↘ 49 (49) ↘ 9 (18) ↘ 110 (416) ↘ 21 (74)	↘ 7 (8) ↘ 22 (68) ↘ 19 (17) ↘ 9 (26) ↘ 119 (513) ↘ 14 (27)	↘ 43 (43) ↘ 932 (932) ↘ 3 (3) ↘ 2 (2) ↘ 0 (0) ↘ 2 (2)	

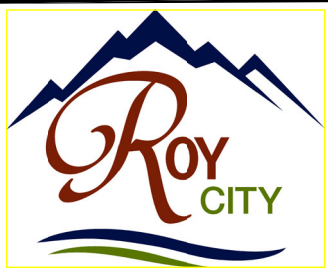
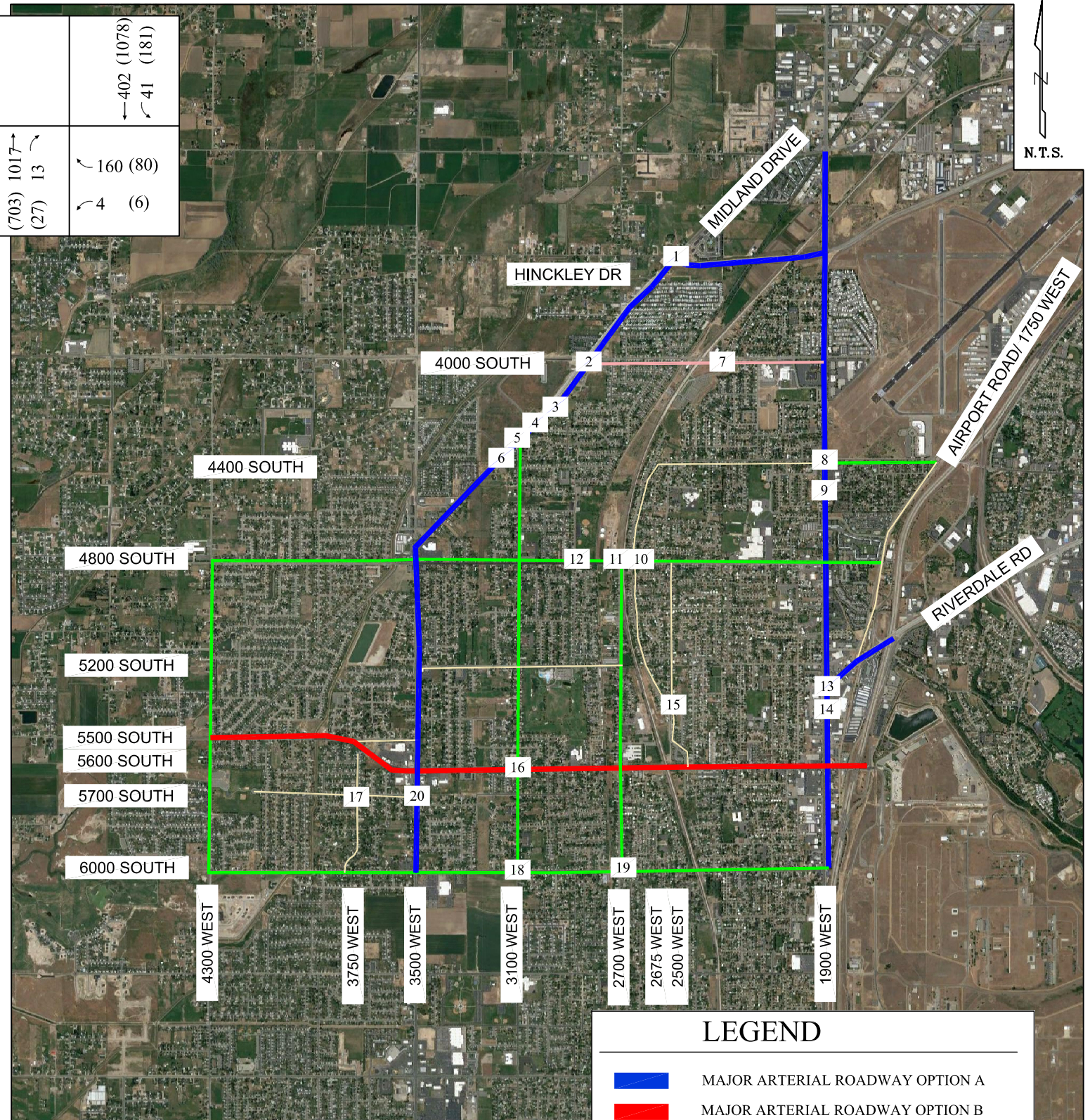

5051 South 1900 West
Roy, Utah 84067

November 2018

Figure 3

Existing Intersection Turning Movement Counts

1 B [Signal] C	2 C [Signal] E	3 B [E/W Stop] B	4 D [E/W Stop] C	5 C [E/W Stop] B
6 C [E/W Stop] C	7 C [N/S Stop] D	8 B [Signal] A	9 B [E/W Stop] C	10 C [N/S Stop] D
11 B [Signal] A	12 A [Roundabout] B	13 C [Signal] F	14 A [Signal] A	15 A [E/W Stop] A
16 C [N/S Stop] F	17 A [N/S Stop] A	18 C [N/S Stop] F	19 C [N/S Stop] D	20 A [E/W Stop] A

LEGEND

- [Signal] Signal
- [E/W Stop] E/W Stop Control
- [N/S Stop] N/S Stop Control
- [Roundabout] Roundabout

Intersection #
AM LOS
Intersection Control
PM LOS

Grayscale indicates UDOT ownership

NETWORK LEGEND

- [Blue Line] MAJOR ARTERIAL ROADWAY OPTION A
- [Red Line] MAJOR ARTERIAL ROADWAY OPTION B
- [Magenta Line] MINOR ARTERIAL ROADWAY
- [Dark Green Line] MAJOR COLLECTOR ROADWAY
- [Light Green Line] MINOR COLLECTOR ROADWAY
- [Yellow Line] RESIDENTIAL ROADWAY

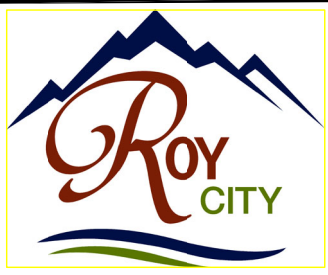
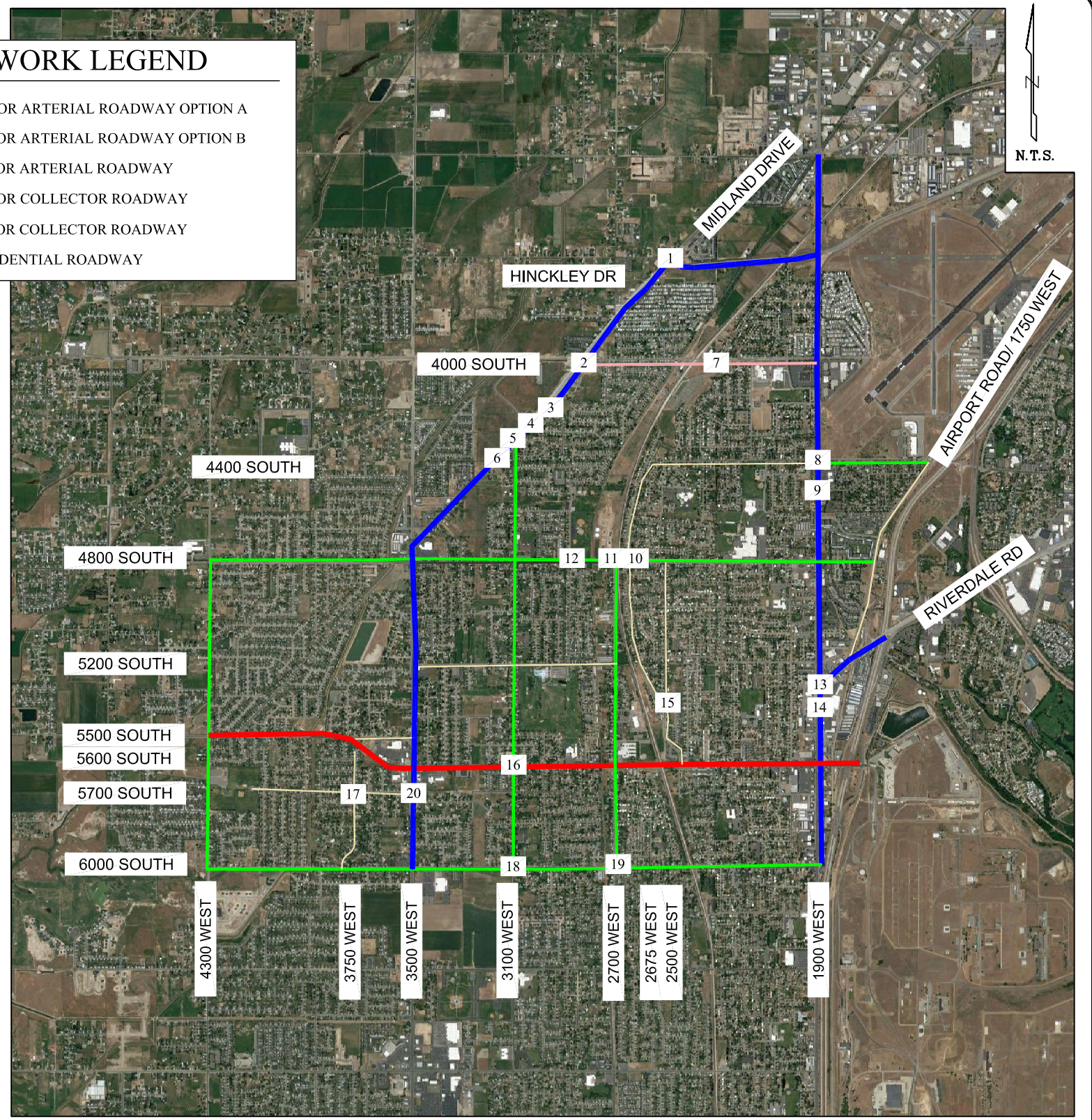

2040 Traffic Projections and Capacity

Future traffic patterns and the resulting operating conditions of a roadway network are directly related to land use planning and socioeconomic conditions. As traffic is not restricted to the Roy City and many of the roadways within the City act as regional roads linking communities north, south, and west of the City, the socioeconomic and land use data in the neighboring cities must also be considered when projecting future traffic conditions within the City. Future growth within the area is based on Wasatch Front Regional Council's 2040 projections. These projections are shown in Figure 5.

FUTURE NETWORK

The goal of the TMP is to provide a transportation network which will accommodate traffic at an acceptable LOS through the year 2040. In order to accomplish this, the capacity of several roadways in the City will need to be increased through the addition of lanes. New roadways will also need to be built to provide connectivity and service new development. Capacity improvements do not always mean widening roadways, although this is often the case. In some cases additional capacity can be gained by striping additional lanes where the existing pavement width will accommodate it. This can be accomplished by eliminating on street parking, creating narrower travel lanes, and adding two-way left turn lanes where they don't currently exist.

LEGEND

2040 AADT WFRC XXXX
Wasatch Front Regional Council (WFRC)

- █ MAJOR ARTERIAL ROADWAY OPTION A
- █ MAJOR ARTERIAL ROADWAY OPTION B
- █ MINOR ARTERIAL ROADWAY
- █ MAJOR COLLECTOR ROADWAY
- █ MINOR COLLECTOR ROADWAY
- █ RESIDENTIAL ROADWAY

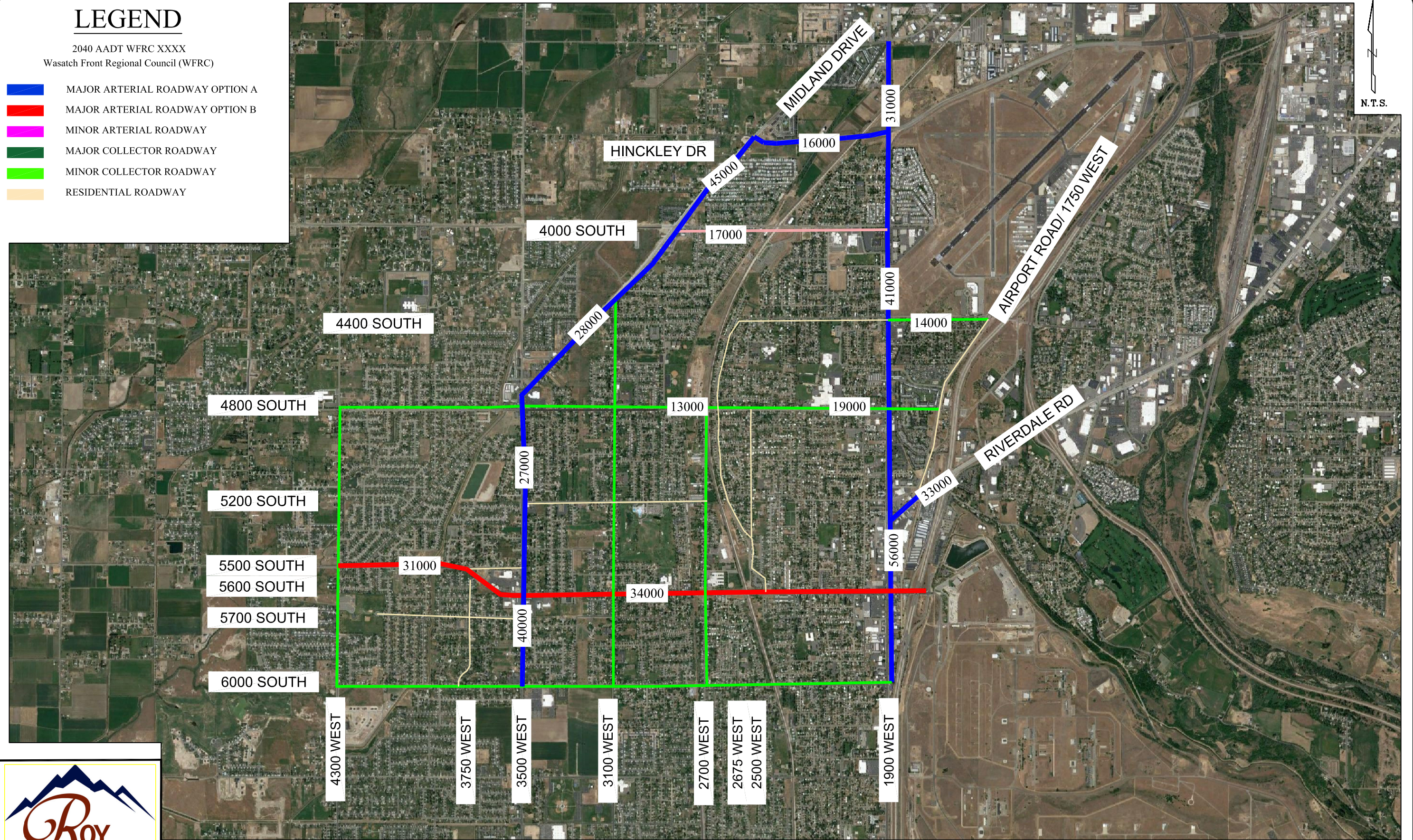

N.T.S.

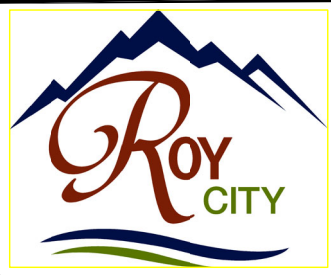

5051 South 1900 West
Roy, Utah 84067

November 2018

Figure 5

2040 WFRC AADT Projections

FUTURE IMPROVEMENTS

Any type of potential intersection improvements, including new roadways, additional traffic lanes on existing roadways, and changes to traffic control are considered. Roy City must approve the recommended improvements prior to any specific improvements being made. This plan indicates the places where intersection improvements may be made but does not specify the type of improvement as multiple options will likely be feasible at each location and each location should be studied and analyzed individually. Right-of-Way requirements and widening will depend on the type of treatment selected for each intersection. Potential intersection improvement locations are identified.

ROUNDBABOUTS AS INTERSECTION IMPROVEMENTS

At unsignalized intersections of two-lane roadways that are projected to operate at a poor level of service, Roy City strongly recommends evaluation of a modern roundabout as a mitigation measure over the installation of traffic signals. (Reference: “Roundabouts: An Informational Guide”, U.S. Department of Transportation, Federal Highway Administration, Publication No. FHWA-RD-00-067). According to FHWA, many international studies have found that one of the most significant benefits of a roundabout installation is the improvement in overall safety performance. Specifically, in the United States, it has been found that single-lane roundabouts operate more safely than two-way stop-controlled intersections. The frequency of crashes might not always be lowered at roundabouts, but the injury rates are reduced. On a planning level, it can be assumed that roundabouts will provide higher capacity and lower delays than all-way stop control, but less than two-way stop control if the minor movements are not experiencing operational problems. A single-lane roundabout may be assumed to operate within its capacity at any intersection that does not exceed peak-hour volumes warranted for signals. A roundabout that operates within its capacity will generally produce lower delays than a signalized intersection operating with the same traffic volumes and right-of-way limitations.

Mini-roundabouts are a type of roundabout characterized by a small diameter and traversable islands (central island and splitter islands). Mini-roundabouts offer most of the benefits of regular roundabouts with the added benefit of a smaller footprint. As with roundabouts, mini-roundabouts are a type of intersection rather than merely a traffic calming measure, although they may produce some traffic calming effects. They are best suited to environments where speeds are already low and environmental constraints would preclude the use of a larger roundabout with a raised central island. Mini-roundabouts are common in the United Kingdom

(U.K.) and France and are emerging in the United States (including states such as Maryland and Michigan), Germany, and other countries. FHWA has published a technical summary regarding mini-roundabouts (FHWA-SA-10-007) and Roy City will consider the application of mini-roundabouts in the future.

TRAFFIC SIGNALS AS INTERSECTION IMPROVEMENTS

The need for new traffic signals will be based on warrants contained in the Manual on Uniform Traffic Control Devices (MUTCD) and any additional warrants established by the National Committee on Uniform Traffic Control Devices. In determining the location of a new signal, traffic progression is of paramount importance. Generally, a minimum spacing of one-half mile for all signalized intersections should be maintained. This spacing is usually desirable to achieve good speed, capacity, and optimum signal progression. The one-half mile signal spacing standard may be relaxed on lower volume collector streets where an engineering study shows that traffic progression can be maintained. Pedestrian movements must be considered in the evaluation. To provide flexibility for existing conditions and ensure optimum two-way signal progression, an approved traffic engineering analysis must be made to properly locate all proposed accesses that may require signalization. The section of roadway to be analyzed for signal progression will be determined by the City and will include all existing and possible future signalized intersections.

A traffic control signal should only be installed if and when the warrant criteria outlined in Chapter 4C of the MUTCD are met. It is, however, possible to predict where traffic control signals may be warranted in the future based on projected traffic volumes and roadway functional classifications. A traffic control signal may be warranted where an arterial meets an arterial and may sometimes be warranted where an arterial street meets a collector street. They are rarely warranted where a collector street meets a collector street and almost never warranted where local streets connect and other traffic control such as a modern roundabout or a mini-roundabout is recommended.

STOP-CONTROL AS INTERSECTION IMPROVEMENTS

Wherever possible the City is encouraged to use roundabouts to control traffic on low to medium volume roadways. In cases where this is not feasible, due to financial restraints or sight distance concerns, stop-control may be an appropriate intersection treatment. Four-way stop control should be avoided on Collector streets and prohibited on Arterial streets where possible. In all cases, stop controlled intersections should follow the guidelines and warrants set forth in the MUTCD.

DECELERATION LANES FOR RIGHT TURNING VEHICLES

A right turn deceleration lane is required when one or more of the following criteria is met:

- The design volume of the right turn is less than five vehicles per hour and the outside lane volume exceeds 250 vehicles per hour on 45 to 55 mph roadways, 400 vehicles per hour on 35 to 40 mph roadways, or 600 vehicles per hour on a 25 to 30 mph roadway.
- The access volume meets or exceeds 25 vehicles per hour for roadways with speeds of 25 to 40 mph or 20 vehicles per hour for roadways with speeds in excess of 40 mph.

The recommended roadway network and classification map is shown in Figure 6. To support this classification map, the following approved roadway cross sections for Arterials and Collectors are shown in Figure 7 to 11.

LEGEND

2040 AADT WFRC XXXX
Wasatch Front Regional Council (WFRC)

- █ MAJOR ARTERIAL ROADWAY OPTION A
- █ MAJOR ARTERIAL ROADWAY OPTION B
- █ MINOR ARTERIAL ROADWAY
- █ MAJOR COLLECTOR ROADWAY
- █ MINOR COLLECTOR ROADWAY
- █ RESIDENTIAL ROADWAY

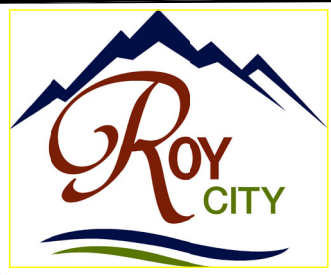
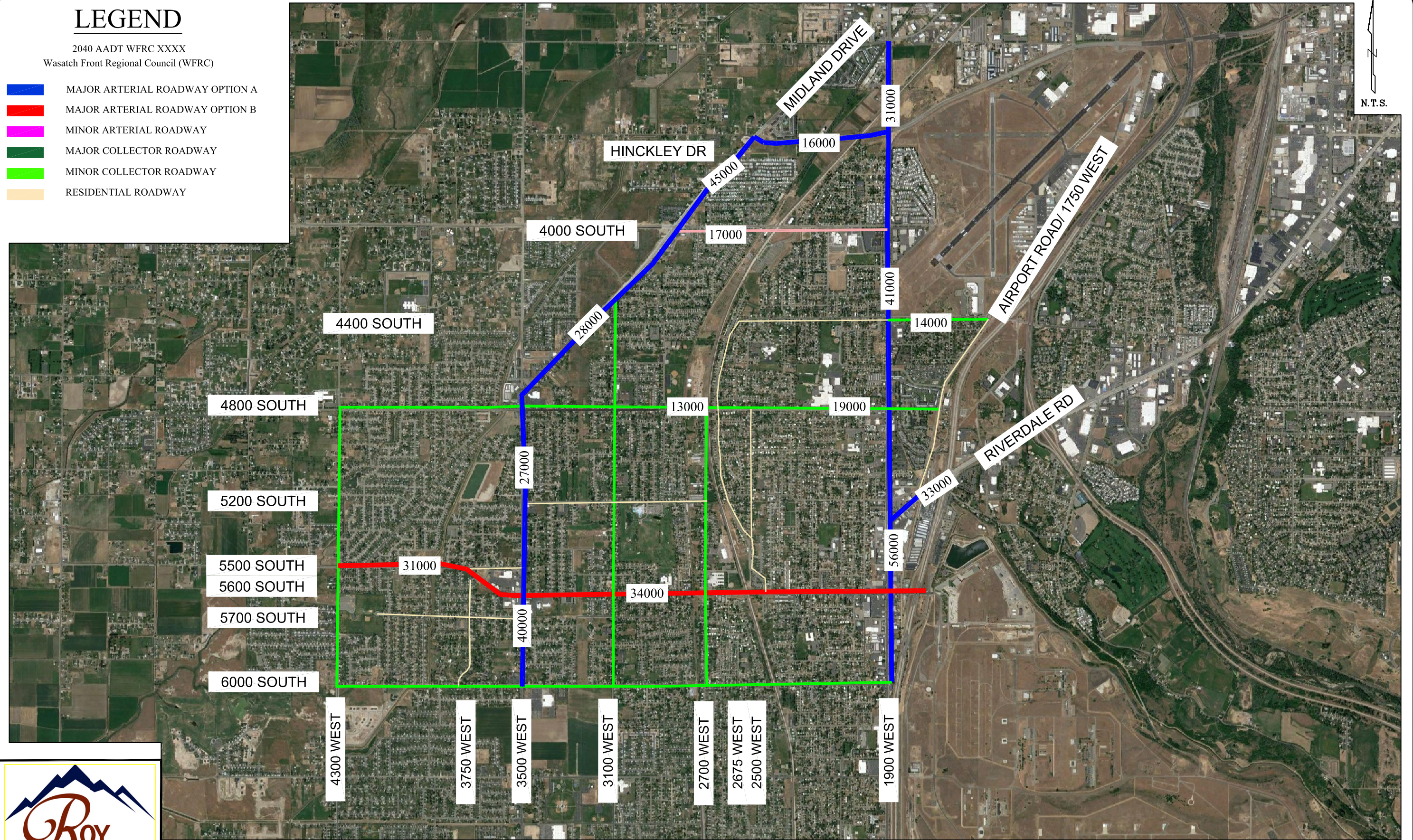















5051 South 1900 West
Roy, Utah 84067

November 2018

Figure 5

2040 WFRC AADT Projections

LEGEND

-  ROUNDABOUT
 -  TRAFFIC SIGNAL
 -  COMMUTER RAIL STATION
 -  FUTURE TRAFFIC SIGNAL
 -  FUTURE ROUNDABOUT
 -  FUTURE ROUNDABOUT or SIGNAL
 -  MAJOR ARTERIAL ROADWAY OPTION A
 -  MAJOR ARTERIAL ROADWAY OPTION B
 -  MINOR ARTERIAL ROADWAY
 -  MAJOR COLLECTOR ROADWAY
 -  MINOR COLLECTOR ROADWAY
 -  RESIDENTIAL ROADWAY
 -  UDOT OWNED ROADWAY
 -  FUTURE COLLECTOR STREETS
- DASHED LINE INDICATES AN IMPROVEMENT IS REQUIRED

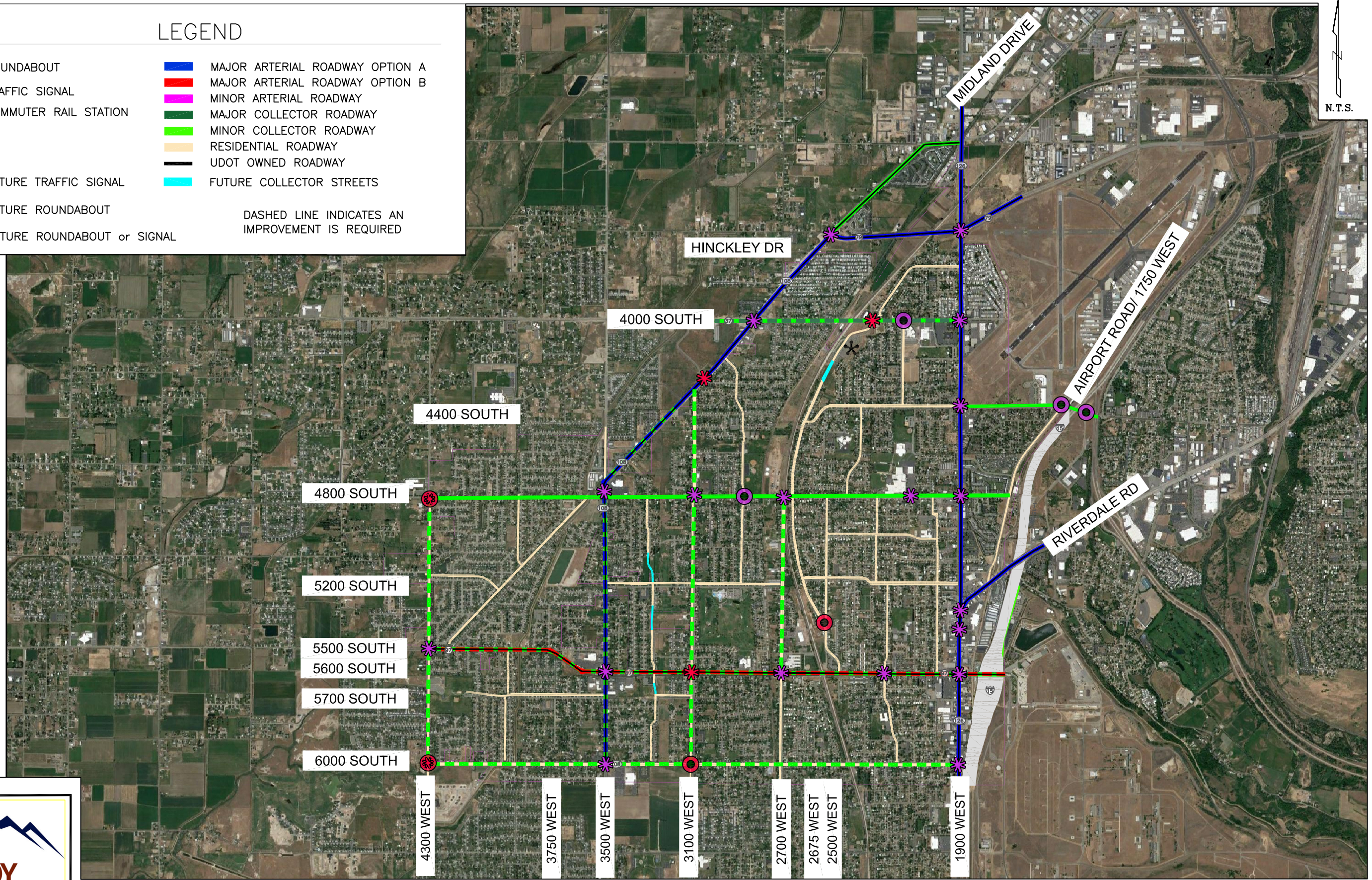

N.T.S.

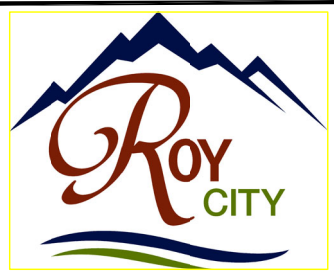

5051 South 1900 West
Roy, Utah 84067

November 2018

Figure 6

Buildout Classification Map

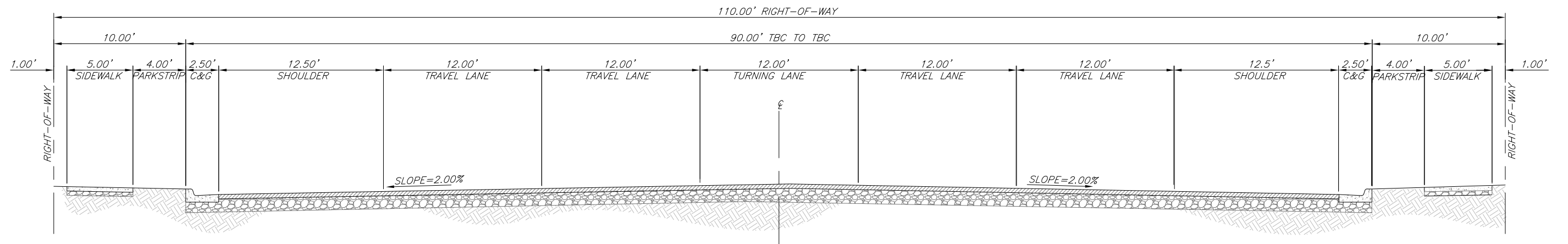

MAJOR ARTERIAL ROADWAY SECTION OPTION A

SCALE: 1" = 8'

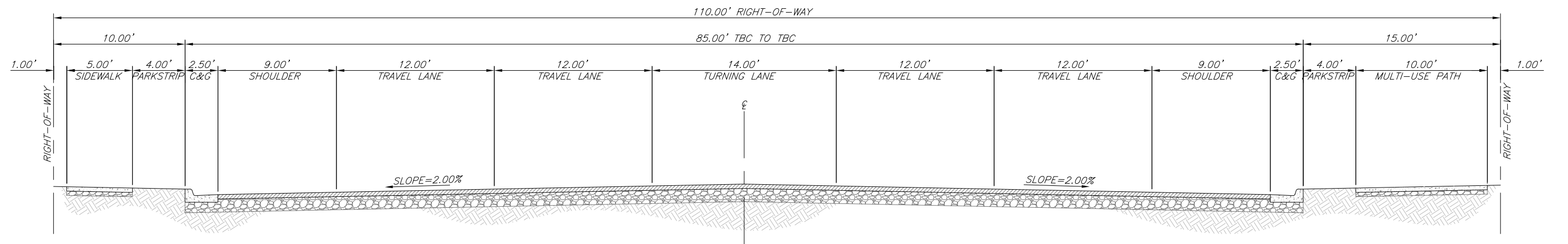

MAJOR ARTERIAL ROADWAY SECTION OPTION B (ALONG BIKE ROUTE)

SCALE: 1" = 8'



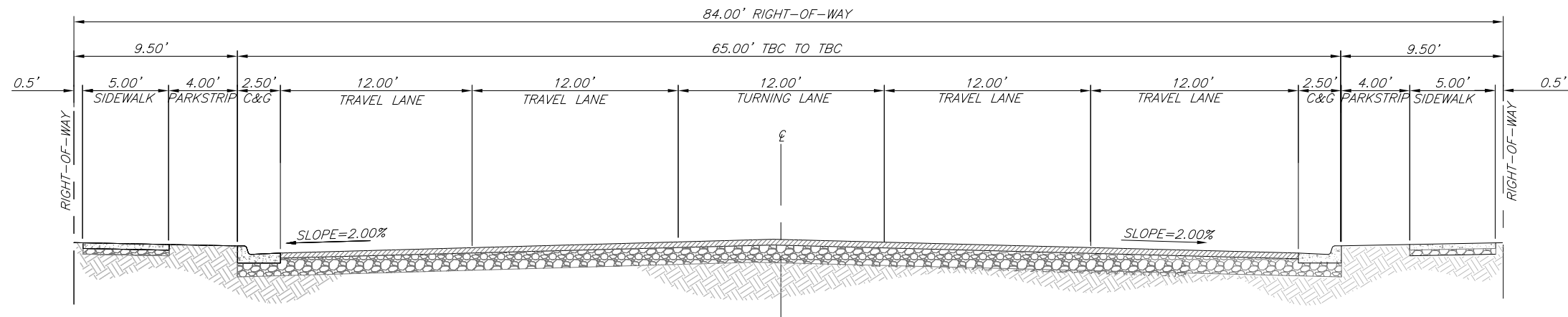

MINOR ARTERIAL ROADWAY SECTION OPTION A
SCALE: 1" = 8'

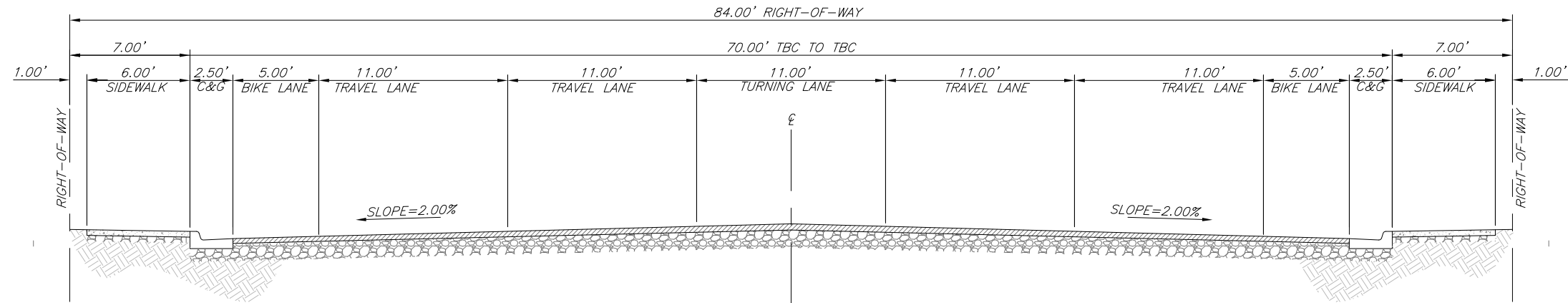

MINOR ARTERIAL ROADWAY SECTION OPTION B (ALONG BIKE ROUTE)
SCALE: 1" = 8'



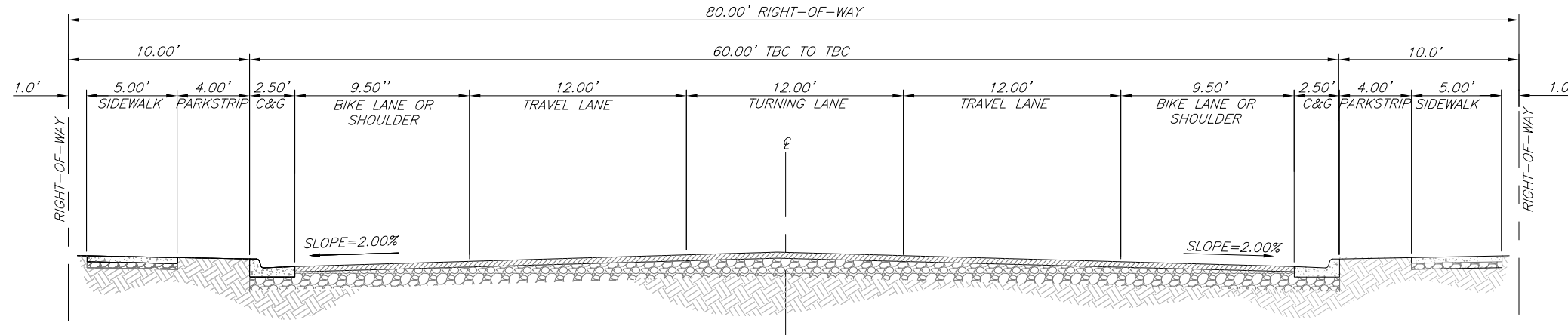

MAJOR COLLECTOR ROADWAY SECTION OPTION A
SCALE: 1" = 8'

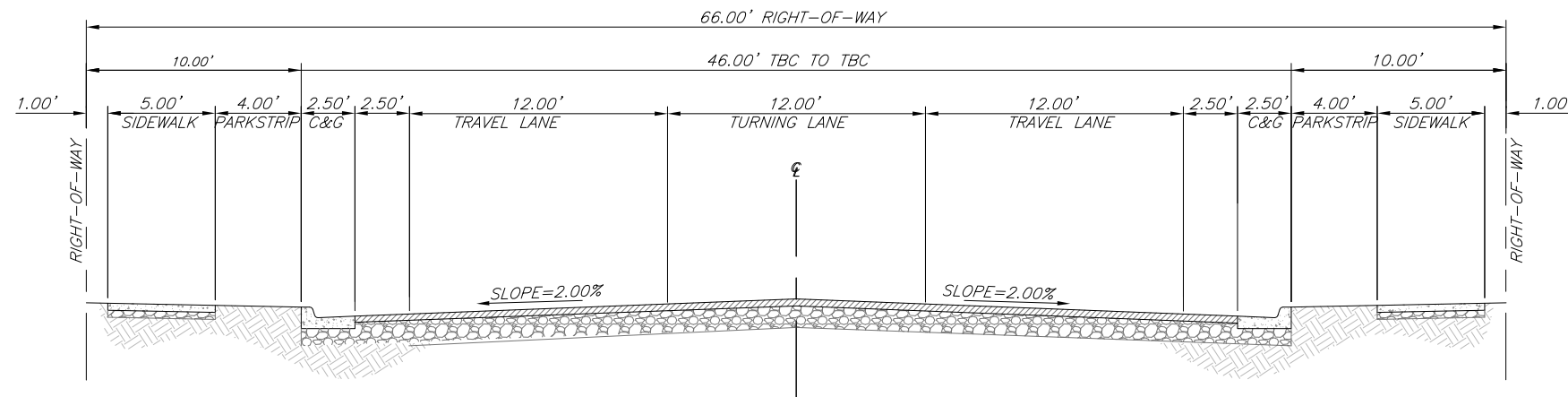

MINOR COLLECTOR ROADWAY SECTION OPTION A
SCALE: 1" = 8'

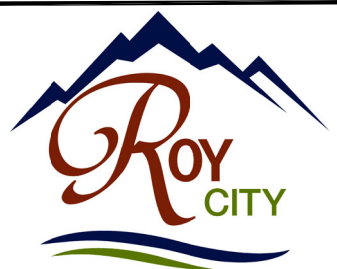

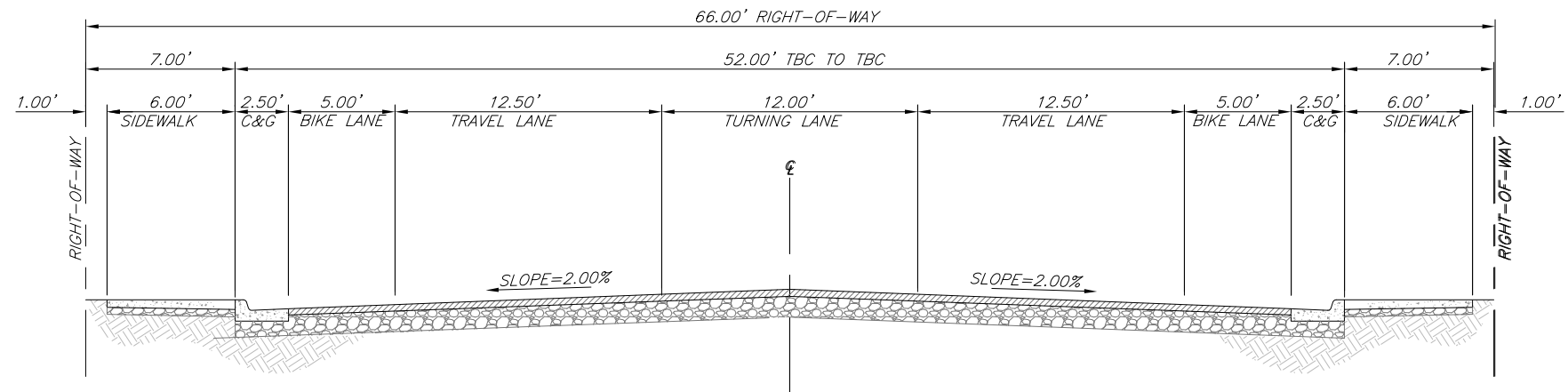

MINOR COLLECTOR ROADWAY SECTION OPTION B
 SCALE: 1" = 8'

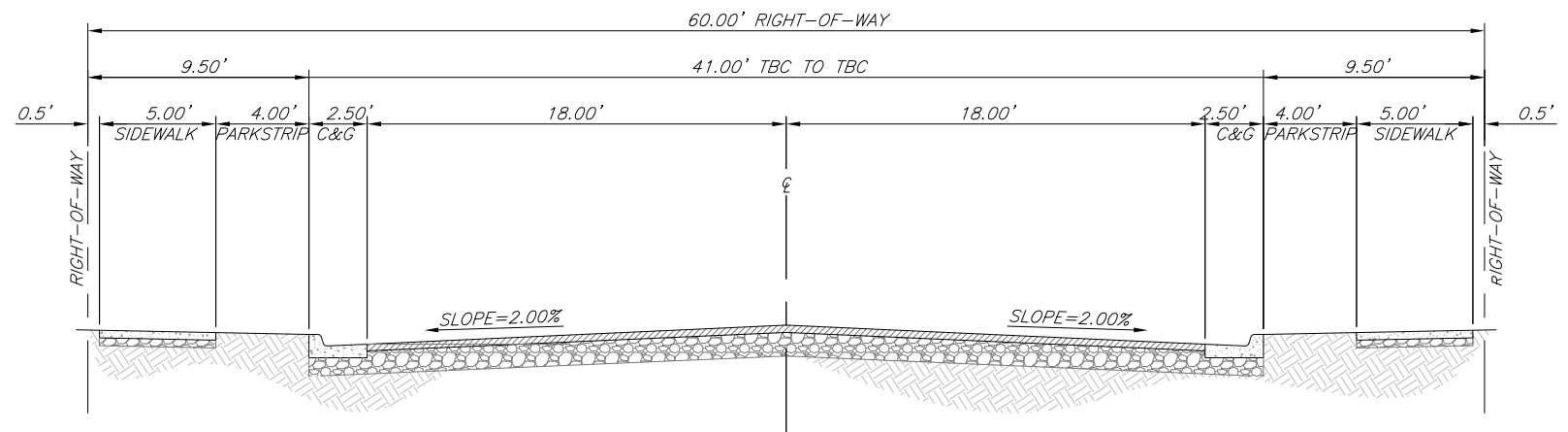

STANDARD RESIDENTIAL ROADWAY SECTION OPTION A
 SCALE: 1" = 8'



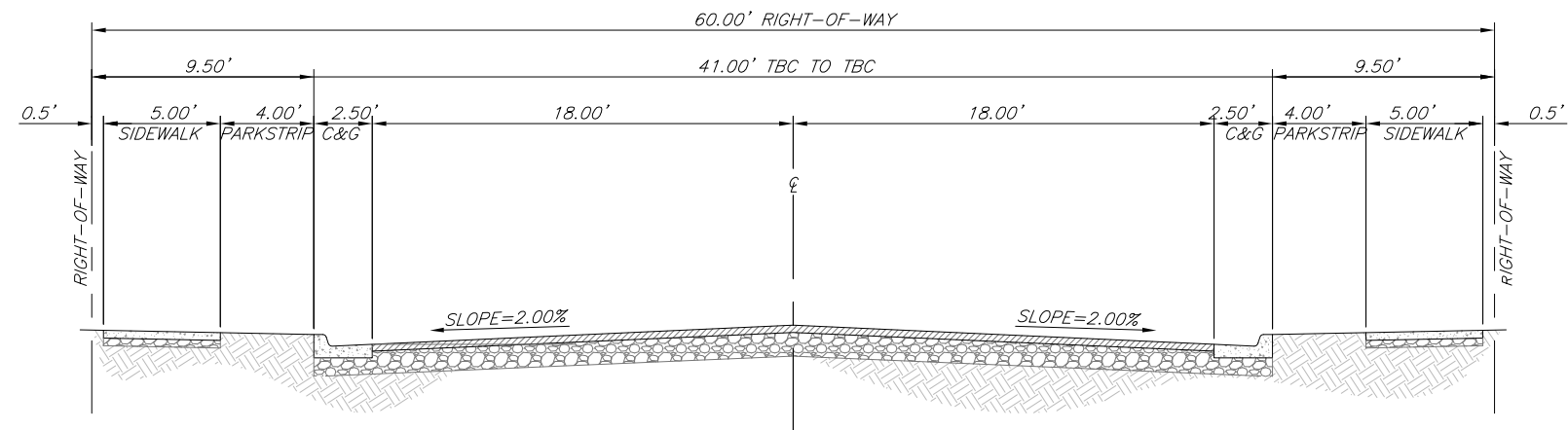

STANDARD RESIDENTIAL ROADWAY SECTION OPTION A
 SCALE: 1" = 8'



Alternative Transportation methods

Accommodating alternative modes of transportation is a vital consideration when planning a livable and sustainable community. It is important for Roy City to continue to plan for improved transit, trails, and pedestrian facilities. These facilities will improve the overall quality of life of the residents while aiding in congestion relief and increasing the lifespan of the City's roadway network.

TRANSIT ROUTES

Figure 12 identifies the existing UTA transit routes and transit stops within Roy. Roy is served by a commuter rail station on 4000 South. There are no current plans to expand the existing transit UTA service within Roy.

PEDESTRIANS AND BICYCLES

Pedestrian and bicycle safety is an important feature of any transportation master plan. People will be more inclined to walk or ride their bicycle when the experience is pleasant, safe, and distances are reasonable. High-density housing near high-traffic generators or main street type areas encourages people to use alternative travel options to the automobile. Provision has been made in the design of the typical cross-sections for use in Roy City to accommodate pedestrian and bicycle facilities.

Figure 13 identifies the existing and proposed trails and bike routes. The bike routes include shared bike routes, bike paths and multiuse pathways. The difference between a shared bike route and separate bike lanes is a function of the available asphalt width.

The City should discourage the placement of marked (painted) crosswalks on Arterial and Collector streets at locations not controlled by either a crossing guard, or a traffic control device such as a STOP sign, Rapid Rectangular Flashing Beacon (RRFB), Hybrid Pedestrian Beacon (HAWK) signal or a regular Traffic Signal. Marked crosswalks are discouraged at uncontrolled midblock locations. When the City receives new requests for marked crosswalks at uncontrolled midblock locations they should follow the guidelines developed by the Federal Highway Administration (FHWA).

It is recommended that Roy City develop a pedestrian sidewalk inventory and identify the following:











- Connect all areas of the City
- Fill critical gaps in the walking and bicycling networks
- Identify existing and planned facilities on the City’s perimeter so that recommended facilities provide seamless connections to surrounding communities
- Where possible, recommend facility types that serve the widest range of users, particularly those who are less comfortable riding bicycles in close proximity to traffic
- Recommend facilities than can feasibly be constructed and maintained by the City
- Use a phased implementation approach that provides logical short- and medium-term recommendations, while retaining long-term visionary recommendations
- Avoid impacting on-street parking or traffic lanes along the critical roadways where those impacts would be highly undesirable

RECOMMENDED BIKE PATHS

The map of the proposed bicycle and trail facilities network is shown in Figure 13. All of the proposed street Arterial and Collector street cross-sections allow for the addition of bicycle lanes. Before a bicycle lane can be installed on a roadway, the roadway itself must be complete along the entire extent of the bicycle path. Missing shoulders and incomplete segments pose a serious hazard to bicyclists.

Bicycle and pedestrian crossings are an important part of the transportation network. The trails map identifies areas of the City where trails and bike facilities are recommended. Wherever these facilities intersect a roadway, a safe and convenient crossing should be installed. These crossings can come in the form of standard pedestrian crossings at intersections, midblock HAWK signal crossings, grade separated bridges and tunnels, or standard pedestrian midblock crossings. Each crossing location must be treated individually and should follow the guidelines set forth in the MUTCD. The MUTCD also provides a specific set of criteria for when a pedestrian crossing is warranted based on vehicular and pedestrian traffic, proximity to high pedestrian generators such as schools, and safety considerations. In each case an engineering study should be performed before an at-grade pedestrian crossing is installed.

LEGEND

-  FRONTRUNNER COMMUTER RAIL
-  ROUTE 604 TRANSIT STOP
-  ROUTE 640 TRANSIT STOP
-  ROUTE 626 TRANSIT STOP
-  MAJOR ARTERIAL ROADWAY OPTION A
-  MAJOR ARTERIAL ROADWAY OPTION B
-  MINOR ARTERIAL ROADWAY
-  MAJOR COLLECTOR ROADWAY
-  MINOR COLLECTOR ROADWAY
-  RESIDENTIAL ROADWAY

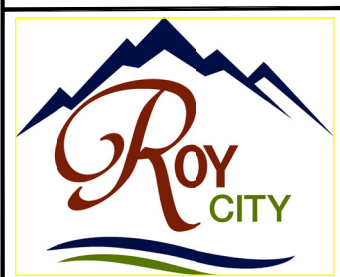
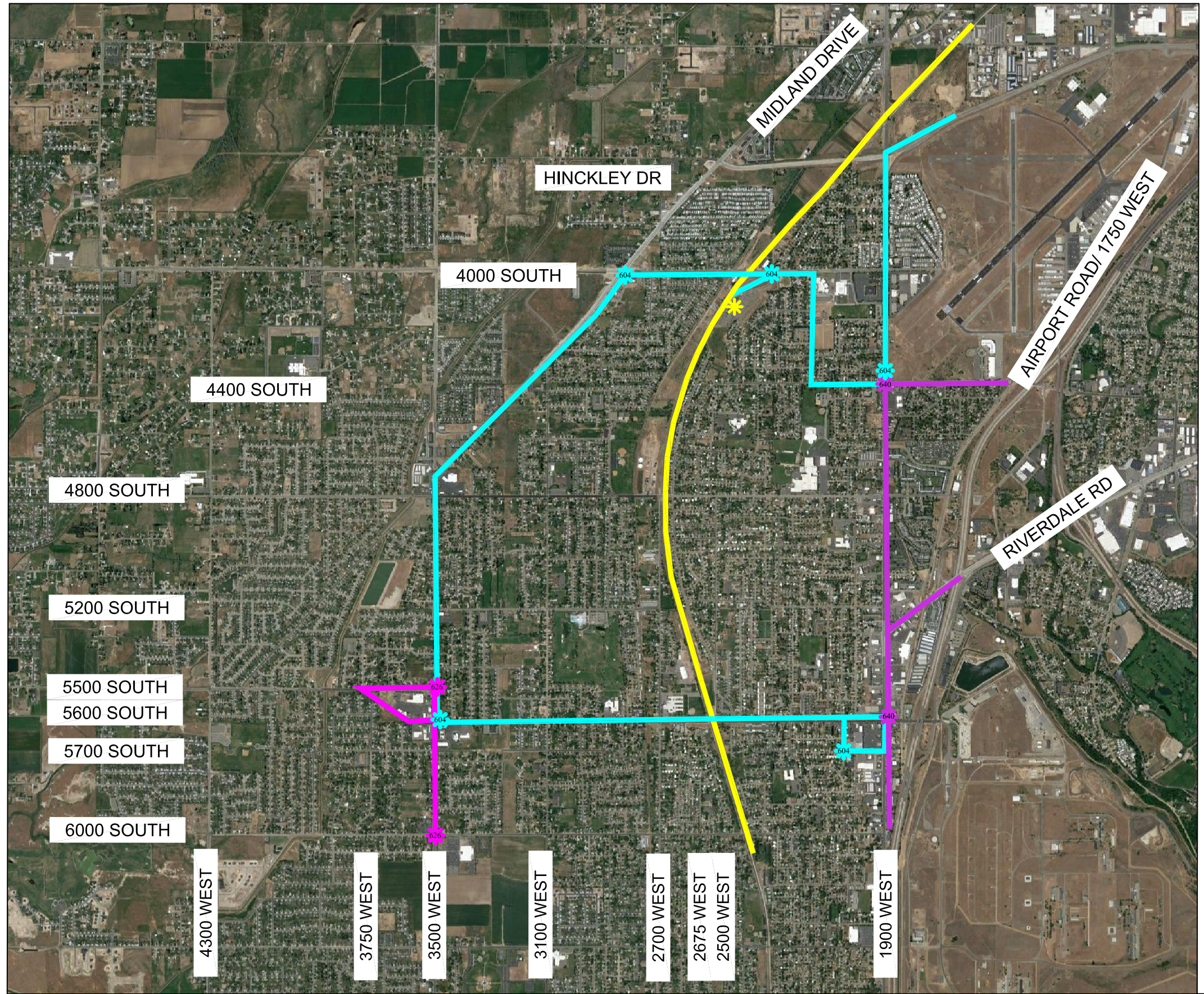

5051 South 1900 West
Roy, Utah 84067

November 2018

Figure 12

Transit Facilities Map

LEGEND

- █ EXISTING TRAIL
- █ EXISTING BIKE LANE
- █ PROPOSED BIKE ROUTES
- █ FUTURE MULTI-PURPOSE TRAILS
- ✱ FUTURE TRAIL CROSSING
- TRAIL CROSSING TO BE IMPROVED
- FUTURE GRADE SEPARATED TRAIL CROSSING
- EXISTING HAWK CROSSING

N.T.S.

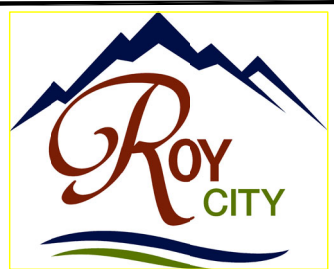
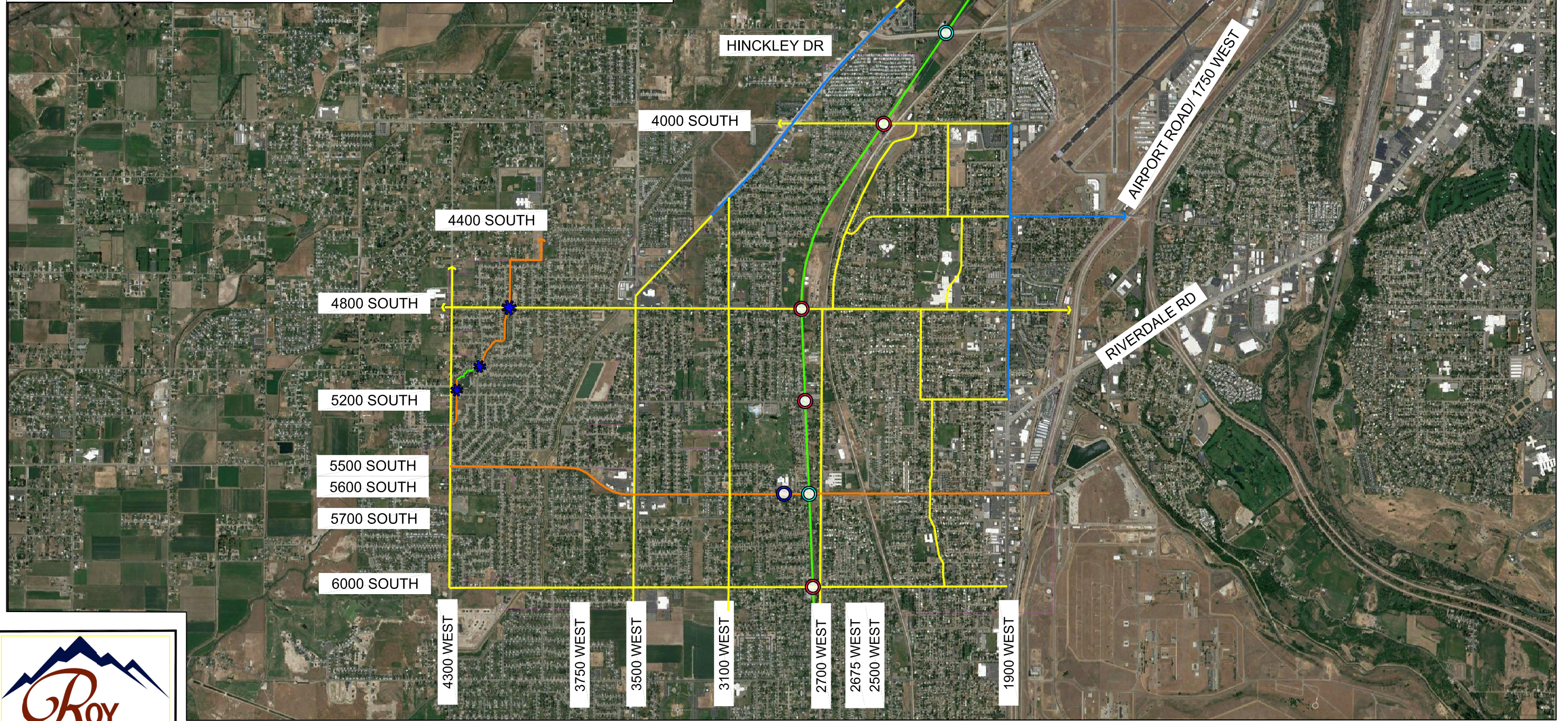

5051 South 1900 West
Roy, Utah 84067

November 2018

Figure 13

Trails and Bike Plan

Speed Analysis

A speed analysis provides information on the existing speed limit and the measured 85th percentile speed along a road. Unless otherwise legislated, speeds limits are typically based on the 85th percentile measured speeds. Artificially reducing speed limits is not typically effective and leads to an inherent speeding concern.

LEGEND

- XX POSTED SPEED LIMIT
- (XX) 85th PERCENTILE SPEED
- MAJOR ARTERIAL ROADWAY OPTION A
- MAJOR ARTERIAL ROADWAY OPTION B
- MINOR ARTERIAL ROADWAY
- MAJOR COLLECTOR ROADWAY
- MINOR COLLECTOR ROADWAY
- RESIDENTIAL ROADWAY

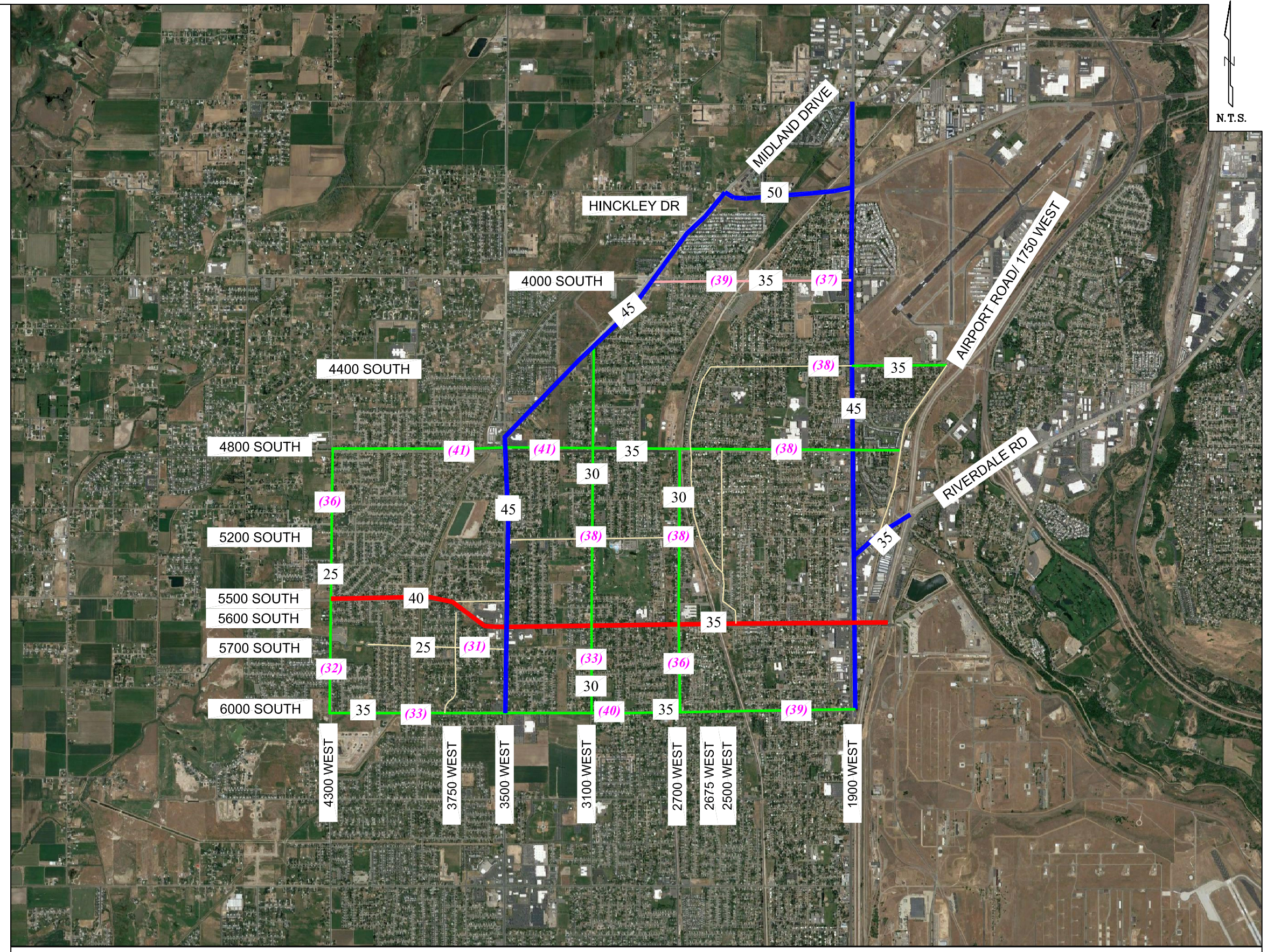

N.T.S.

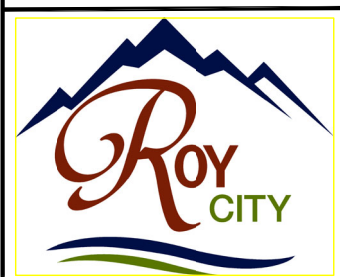

5051 South 1900 West
Roy, Utah 84067

November 2018

Figure 14

Posted Speed and 85th Percentile Speeds

Traffic Calming

Traffic calming is a combination of vertical, horizontal and visual roadway modifications to reduce travel speeds along a corridor. These are primarily applied to residential and minor collector roadways once a speeding concern is identified. There are multiple options for traffic calming implementation. Figure 15 identifies the preliminary traffic calming location based on existing data and observations. The calming implementation technique is site specific and requires evaluating each location.

Traffic calming provides many benefits to pedestrians and to the creation of livable neighborhoods. Traffic calming and slower traffic enhances pedestrian safety by:

- Decreasing the probabilities of a car-pedestrian collision;
- Reducing the severity of injuries should a collision occur;
- Making it easier and less intimidating for pedestrians to cross streets.

Traffic calming and slower traffic encourage more walking and bicycling by improving the ambiance of the neighborhood and more livable streets by:

- Producing less traffic noise; and
- Reducing the level of air pollution.

Street patterns are typically developed at the time of construction. In Utah, the history of using a grid system for planning and development purposes started with the first settlers and has proven efficient for moving people and goods throughout a network of surface streets. However, the nature of a grid system with wide and often long, straight roads can result in excessive speeds. For that reason, traffic calming measures (TCM) can be implemented to reduce speeds on residential roadways. Roy City follows the Utah grid system with some interruptions due to the airport, existing state highway layout, terrain and railroad tracks. Traffic calming is, however, still applicable to many neighborhoods or local streets and should be given consideration on the City's local and residential streets on a case-by-case basis where applicable.

Traffic calming may be applied to existing City streets when requested by the neighborhood but should always be included during the development of new neighborhood streets and subdivisions. Roy City should consider adopting the Neighborhood Traffic Management Program (NTMP) that addresses the desire of residents and City leaders to organize a method for addressing high speeds through residential neighborhoods. When considering the installation of traffic calming devices, refer to the City's adopted traffic calming program.

The Institute of Transportation Engineers (ITE) has established a definition for traffic calming that reads, “traffic calming is the combination of mainly physical measures that reduce the negative effects of motor vehicle use, alter driver behavior and improve conditions for non-motorized street users.” Altering driver behavior includes lowering of speeds, reducing aggressive driving, and increasing respect for non-motorized street users.

The following paragraphs give a brief overview of traffic calming methods.

TYPES OF TRAFFIC CALMING MEASURES

There are several types of TCM that can be grouped into three categories, depending on the level of control or the effect on traffic flow and speeds. Category 1 measures are the least restrictive, while Category 3 is the most dramatic. These categories are outlined in further detail in the following sections. Several factors can influence the choice of TCM used, including the location, street classification, street geometry, adjacent land uses, public transit needs, budget, climate, aesthetics, and community preferences.

CATEGORY ONE – Non-Physical Measures

Traffic control devices consist of signs, signals, and pavement markings to regulate, warn, guide, and provide information to drivers. Examples include regulator signs (i.e., speed limit signs), warning signs (i.e., pedestrian warning signs), traffic signals, etc. Often traffic control devices are overused as TCMs. Though the function of traffic calming devices is often similar to that of other TCMs, specific traffic control devices should not be overused to communicate different purposes. One of the primary purposes of traffic control devices is to inform drivers of traffic laws and specific right-of-ways in order to maintain order and safety. Overuse of such traffic control devices diminishes their intended purpose. For example, the MUTCD states “stop signs should not be used for speed control.” When used following the guidelines outlined in the MUTCD, traffic control devices can assist as part of roadway/intersection designs to calm traffic where necessary.

CATEGORY TWO – Speed Control Measures

Street modification TCMs include actions that physically alter the vertical or horizontal alignment of the roadway. Vertical changes include speed humps, speed tables, raised intersections, etc. Horizontal changes include chicanes and lateral shifts. Other street modification TCMs include constrictions (i.e., narrowing, pinch points, islands, chokers, etc.),

narrow pavement widths (i.e., medians, edge treatments, bulb-outs, etc.), entrance features, roundabouts, traffic circles, small corner radii, street closures, and streetscaping (i.e., surface textures and colors, landscaping, street trees, street furniture, etc.).

CATEGORY THREE – Volume Control Measures

Route modifications consist of altering available routes of traffic flow. Examples include one-way streets, diverters, closures, and turn prohibitions. Instead of attempting to alter drivers' behavior (Categories 1 and 2), route modification TCMs attempt to alter drivers' routes altogether.

STREETSCAPING

Streetscaping includes the planning and placement of items, such as street furniture, lighting, art, trees, landscaping, and side treatments along streets and intersections. Although streetscaping can be implemented without traffic calming, TCMs need a certain element of streetscaping to be functional. Streetscaping softens the appearance of speed humps or tables and enhances the aesthetics of roundabouts and constrictions, etc. Landscaping and other roadside treatments make street closures more effective and safer by highlighting the presence of the measure.

OTHER CONSIDERATIONS

Spacing is an important consideration for TCMs. If TCMs are too far apart (greater than 600 to 1000 feet), speeding can occur between the measures. TCMs should be spaced 200 to 300 feet apart so vehicles will not have sufficient distance to accelerate between measures.

Other considerations when deciding which TCMs to install include snow removal maintenance and emergency vehicle access. Some TCMs may decrease the efficiency of both snow removal and/or emergency vehicle access.

INSTALLATION OF TRAFFIC CALMING MEASURES

When deciding to implement TCMs, the decision should be based on engineering merits of a TCM application, as opposed to public clamor. An engineering study that documents the need for such measures and the nature of the traffic problem via speed and volume measurements should be the determining factor.

The next step is to propose TCMs that are capable of solving the problem and matching the terrain, climate and nature of the street in question. Before implementing these improvements on a more permanent basis, the final step would be to compare the before and after studies for speed and volume changes to see if the TCMs have performed as expected.

In order to make any of the TCMs effective, traffic calming must be community based and as wide spread as possible. For example, the repercussions of traffic calming on one street can result in higher speeds on adjacent streets due to a shift in travel patterns. The need for a community based traffic calming plan is fundamental to the quality of life for the citizens of the community.

Traffic calming programs use a quantitative method of scoring and prioritizing traffic calming needs by gathering speed, volume and other data to rank each citizen request for TCMs.

Accident and Safety Analysis

It is prudent to review the accident history to identify corridor or intersections that should be further evaluated for improvements. Figure 16 identifies the accidents by corridor. A future safety evaluation is recommended to identify the most critical corridors and intersections within the City.

LEGEND

-  TRAFFIC CALMING LOCATION
-  MAJOR ARTERIAL ROADWAY OPTION A
-  MAJOR ARTERIAL ROADWAY OPTION B
-  MINOR ARTERIAL ROADWAY
-  MAJOR COLLECTOR ROADWAY
-  MINOR COLLECTOR ROADWAY
-  RESIDENTIAL ROADWAY

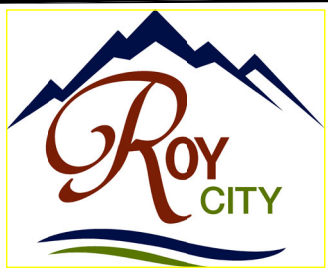
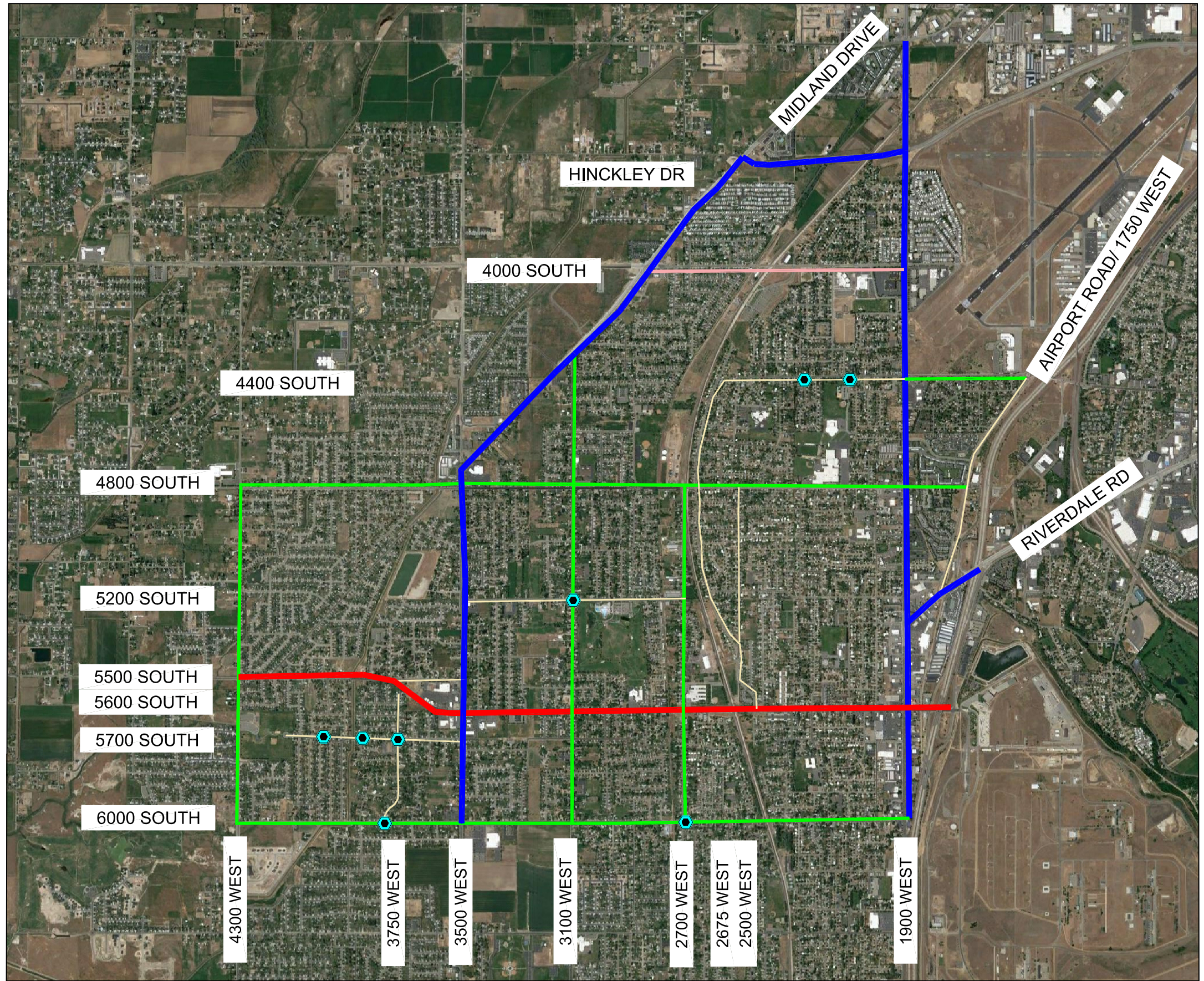

5051 South 1900 West
Roy, Utah 84067

November 2018

Figure 15

Traffic Calming Locations

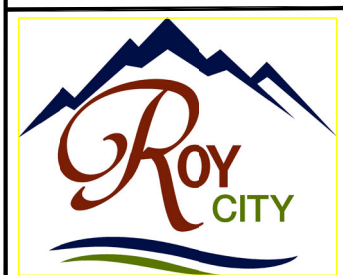

5051 South 1900 West
Roy, Utah 84067

November 2018

Figure 16

Accident Summary

Midland Drive
71 Accidents
4% of Total

2700 West
47 Accidents
3% of Total

3100 West
33 Accidents
2% of Total

3500 West
140 Accidents
8% of Total

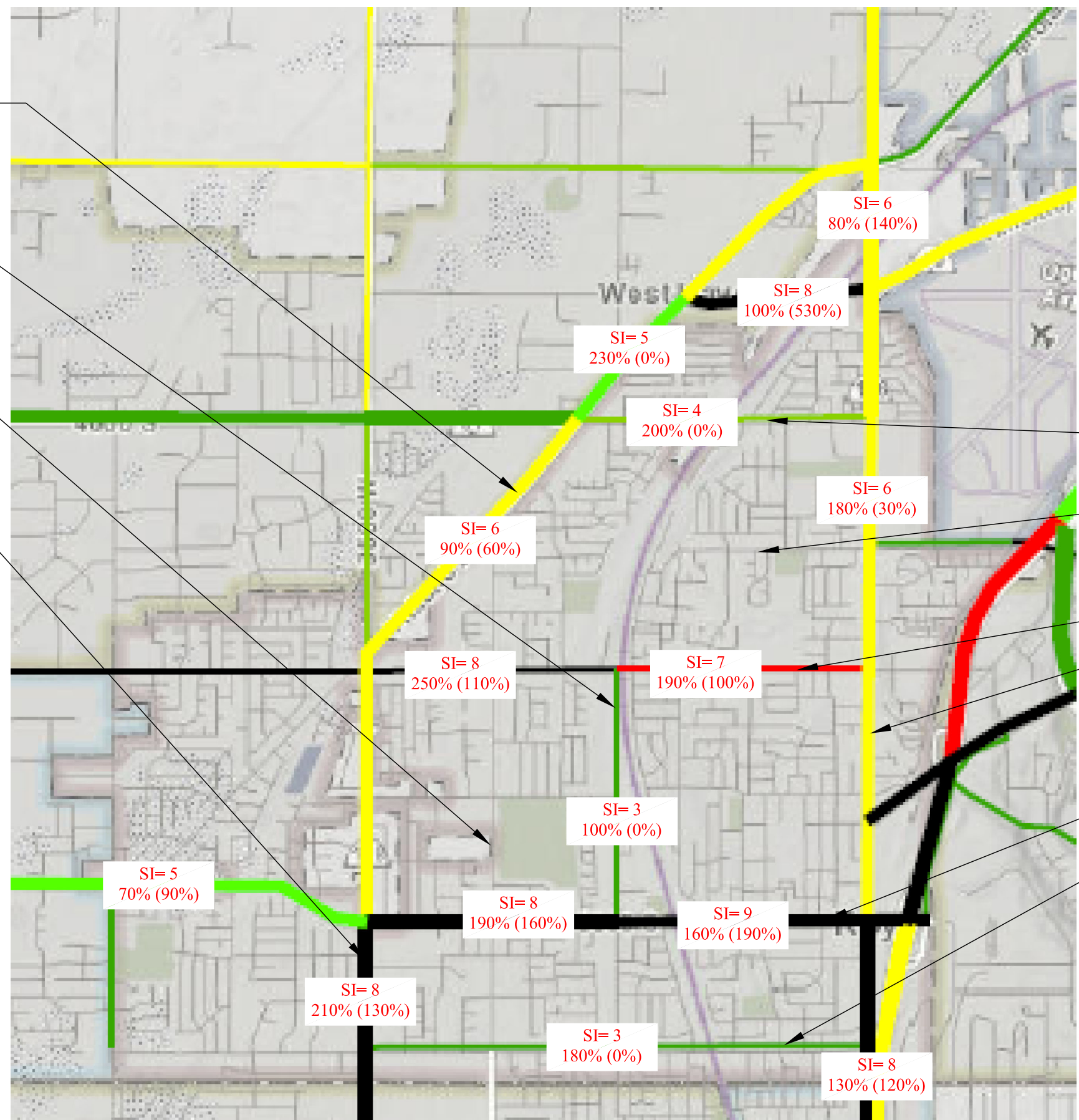

Accidents by Severity
(Severity #, # of Accidents, % of Total Accidents)

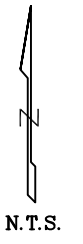
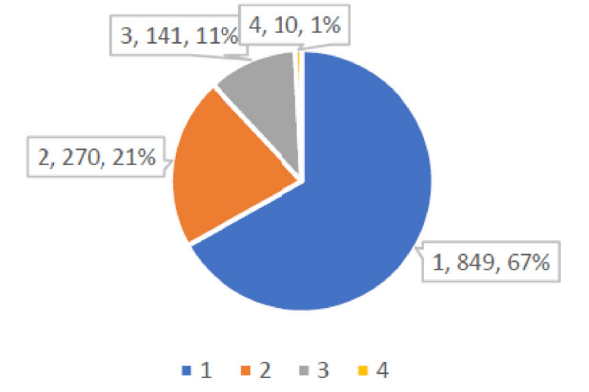

- 4000 South
105 Accidents
6% of Total
- 4400 South
15 Accidents
1% of Total
- 4800 South
222 Accidents
12% of Total
- 1900 West
598 Accidents
33% of Total
- 5600 South
388 Accidents
22% of Total
- 6000 South
54 Accidents
3% of Total

LEGEND

Black Text Roy City Data
Red Text UDOT Traffic and Safety Data
SI = Safety Index
XX% = % of Average Expected Rate
(XX%) = % of Average Expected Severe Crash Rate

Summary of Changes

Table 4 shows the recommended classification improvements that need to be made to accommodate the traffic demand in 2040. These improvements may include widening and/or restriping.

Table 4: Classification Improvements

		Necessary Improvements	Comments
Midland Drive	4800 South to S 4275 South	Collector to Major Arterial	
3500 West	Southern City border to 4800 South	Collector to Major Arterial	
4300 West	Southern City border to 4800 South	Residential to Minor Collector	
2700 West	5600 South to 4800 South	Residential to Minor Collector	For City mobility, this roadway functions as a collector for the City, the existing ROW is sufficient to accommodate the improvement.
6000 South	4300 West to 1900 West	Residential to Minor Collector	
5600 South	4300 West to 1900 West	Collector to Major Arterial	
3100 West	Midland Drive to Southern Border	Residential to Minor Collector	For City mobility, this roadway functions as a collector for the City, the existing ROW is sufficient to accommodate the improvement.
4000 South	Western Border to 1900 West	Minor Collector to Major Collector	

Table 5: Intersection Improvements

Intersection	Recommended Improvement
4800 South / 4300 West	Signal
6000 South / 4300 West	Signal
S 4275 South / Midland Drive (4)	Signal
5600 South / 3100 West (16)	Signal
6000 South / 3100 West (18)	Roundabout
4000 South / Sandridge Drive (7)	Signal
2500 West / 2675 West (15)	Roundabout

Capacity Constraints Summary

EXISTING CAPACITY CONSTRAINTS

- 5600 South to the East of 3500 West is currently over capacity and improvements are recommended.
- 3500 West to the south of Midland Drive is currently over capacity and improvements are recommended.

FUTURE CAPACITY CONSTRAINTS

4000 South was previously classified as a Minor Arterial and is classified within this report as a Major Collector. The volumes projected in the future along this route suggest the classification of a Minor Arterial (5 lanes). Due to right of way constraints and residential units that directly access 4000 South it was determined by the City that this improvement is not likely to be made, therefore the route is classified as a Major Collector with the potential for a maximum of 4 lanes. Due to this artificial limitation on the capacity of the roadway it is estimated that in the future this route will operate with limited mobility and access as growth within the area occurs.

4800 South was previously classified as a Minor Arterial and is classified within this report as a Minor Collector. The volumes projected in the future along this route between 1900 West and 2700 West suggest the classification of a Minor Arterial (5 lanes). Due to right of way constraints and residential units that directly access 4800 South it was determined by the City that this improvement is not likely to be made, therefore the route is classified as a Minor Collector with the potential for a maximum of 3 lanes. Due to this artificial limitation on the

capacity of the roadway it is estimated that in the future this route will operate with limited mobility and access as growth within the area occurs.

3500 West South of 5600 West is projected above capacity for a 5 lane arterial in the future, the shoulder can be converted to an additional travel lane without changing the ROW for the roadway in the future if necessary.

Midland Drive north of 4000 South is projected above capacity for a 5 lane arterial in the future, the shoulder can be converted to an additional travel lane without changing the ROW for the roadway in the future if necessary.